



ASSEMBLY INSTRUCTION

OTIS DINING CHAIR

ITEM CODE 61542

Imported by Amart Furniture Pty Ltd, Qld, Brisbane Australia.

For any assistance with assembly or for missing parts please phone Amart Furniture, Customer Service Free call 1800 351 084

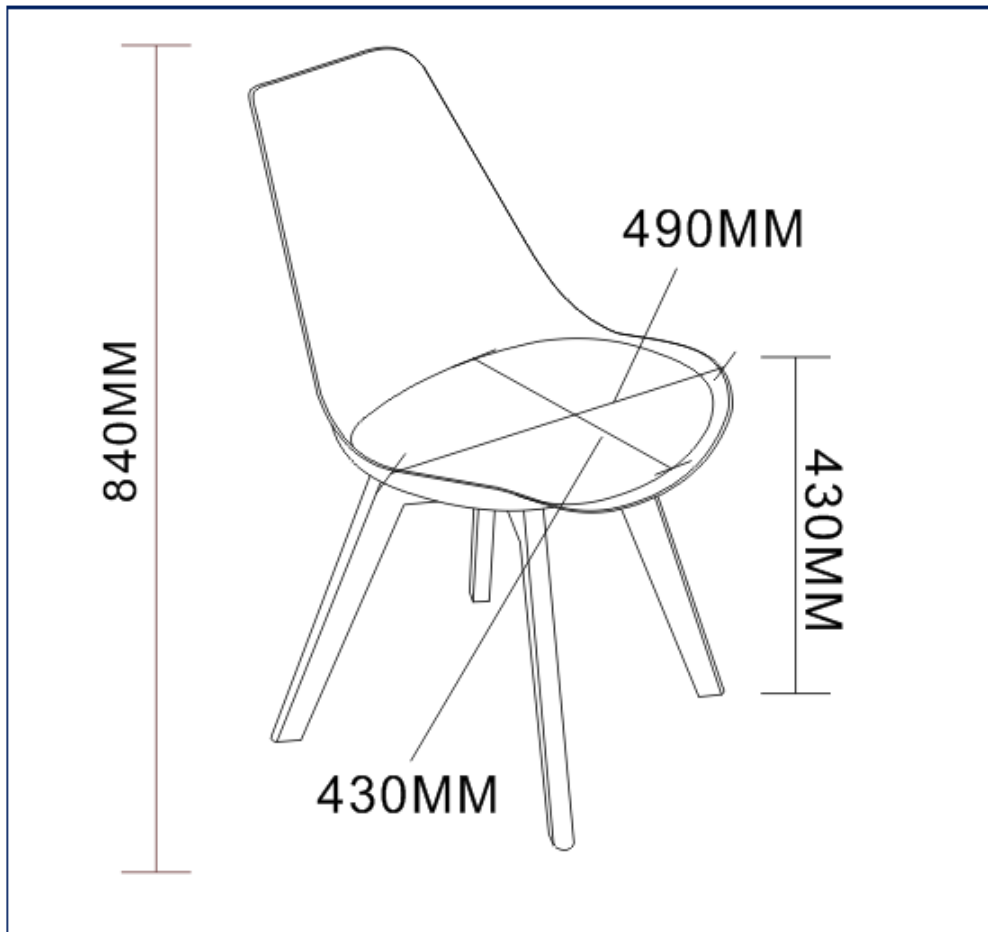

Imported by Amart Furniture Pty Ltd, Brisbane, Qld, Australia.

For any assistance with assembly or for missing parts please phone Amart Furniture, Customer Service Free call 1800 351 084

PRE-ASSEMBLY PREPARATION

Before you start:

1. Choose a clean, level, spacious assembly area. Avoid hard surfaces that may damage the product
2. Take care when lifting. Product should be assembled as near as possible to the point of use
3. Ensure that you have all required contents for complete assembly
4. Always read the assembly instructions carefully before beginning assembly.
5. Keep all hardware parts and packaging out of reach of small children.
6. Do not over tighten the screws and bolts as this may damage the threads

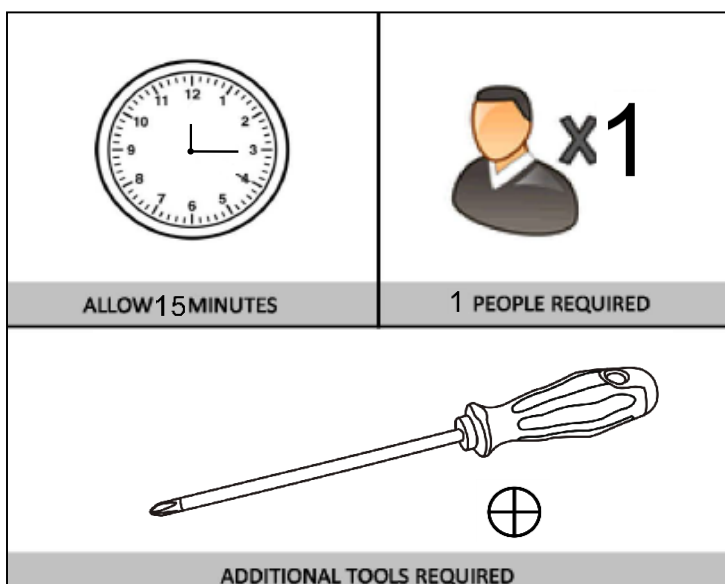

PARTS LIST

A

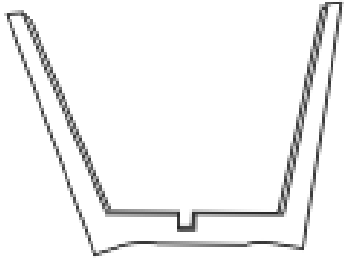



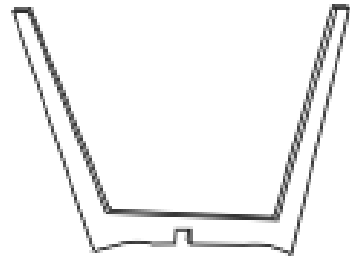

B

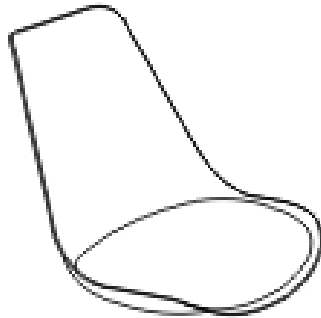

C



A	LEG
B	LEG
C	BACK AND SEAT

D. BOLT M6X35MM  1PCS	E. BOLT M6X55MM  4PCS	F. ALLENKEY  1PCS
G. ANGLE IRON 90°  4PCS	I. SCREW M4X7MM  8PCS	

Step 1

Join the notches together of legs (A) and (B).

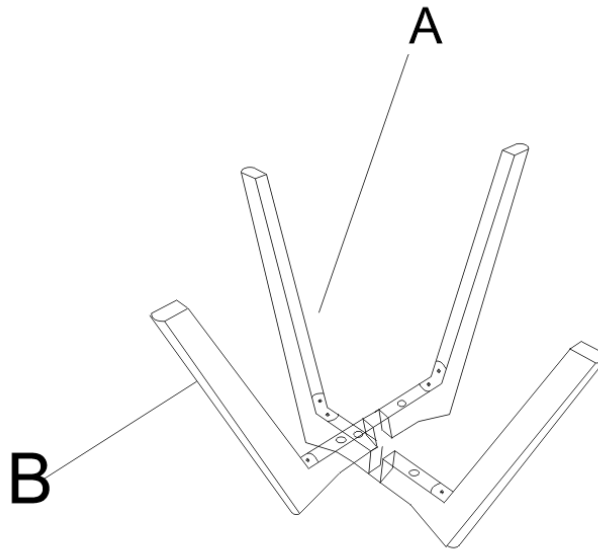

Step 2

Place bolt (D) in the screw hole at the centre and secure with allen key (F).

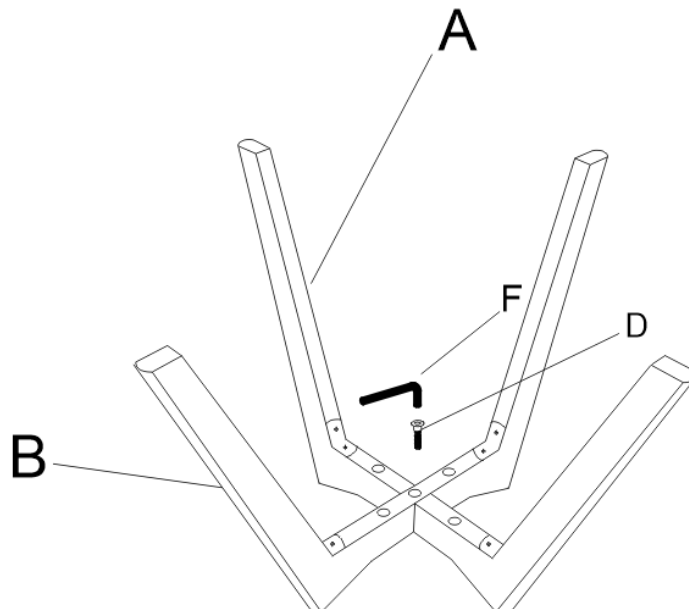

Step 3

Secure 4 brackets (G) as shown with screws (I)

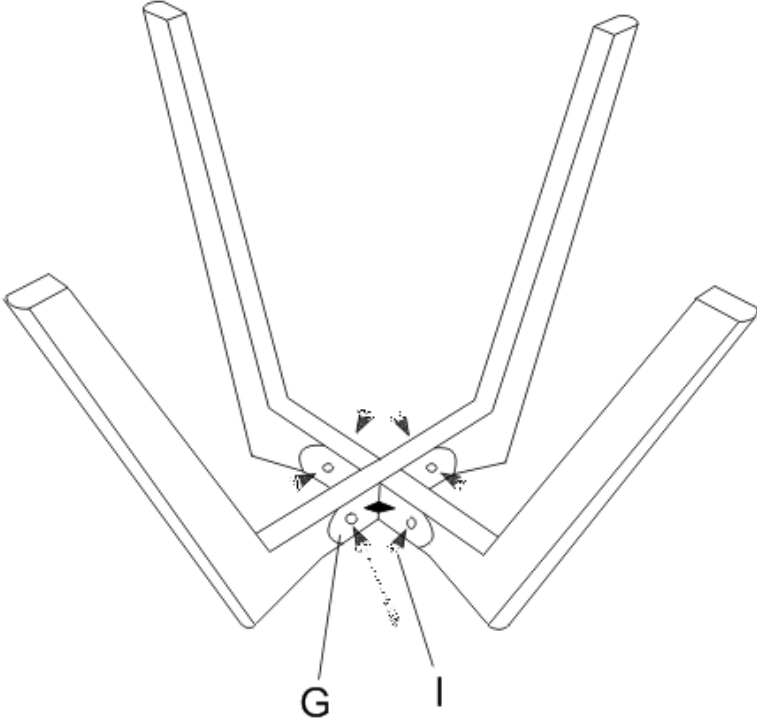

Step 4

Apply 4 screws (E) with allen key (F) as show to secure the legs(A)(B) onto the chair seat (C).

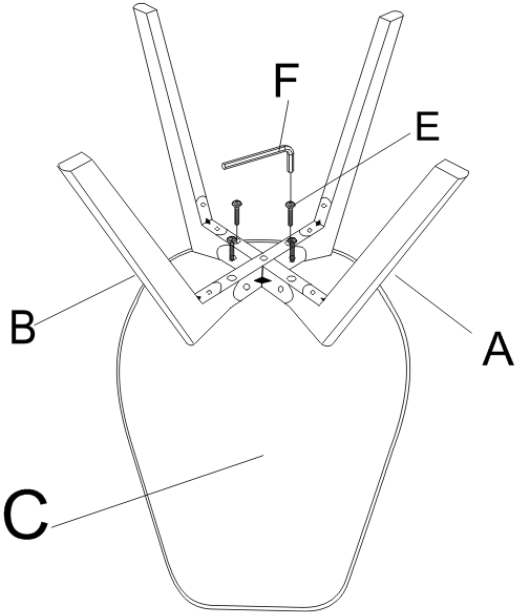



Assembly is complete

Care and maintenance

Regular Care:

- Always protect your product from direct sunlight, direct heat, and weather. Vacuum regularly using a low suction setting.

Cleaning:

- Do not remove cushion covers for separate cleaning even though they may have zips. Do not wash. Do not dry clean. Do not use dishwashing or laundry detergents or solvents. Do not wet the internal filling.
- It is recommended that cleaning be done with a hot water extraction machine only by a professional cleaner.

Spot cleaning:

- Do not rub or scrub. Do not spot clean with any solvent.
- Treat spills and stains as soon as possible.
- Gently scrape any soil or mop and liquid from the surface of the fabric.
- Apply proprietary cleaning agents to the residue of the spill, strictly according to the manufacturer's instructions.
- Do not saturate the fabric or interior filling with water or other cleaning liquids.

Important note:

- Apply only water-based soil resistant (fabric protection) treatments.
- Do not use aerosol fabric protection products.
- Clean timber legs with a clean, soft cloth dampened with water.

Do not:

- Use chair/stool as a ladder
- Climb on the chair/stool
- Stand on the foot-rest of the chair, as this could lead to the stool becoming unbalanced and overturning